

# Projet éolien de la Croix de Mérotte Projet éolien de la Croix de Chalais

Commune de Millac

## Présentation des travaux

26/07/2021

# Intervenants Croix de Chalais

## Maître d'Ouvrage

**Millac Energie**

12 rue Martin Luther King  
14 280 Saint-Contest

## Assistant au Maître d'Ouvrage

**JP Energie Environnement**

12 rue Martin Luther King  
14 280 Saint-Contest

## Coordonnateur SP5 :

**SOCOTEC CONSTRUCTION**  
Domaine du Millénium  
3 impasse Henry le Chatelier  
33 692 MERIGNAC CEDEX  
Tel : 05 57 29 06 10



## Contrôleur technique Génie Civil :

**APAVE Nord-Ouest SAS**  
Zi de la République 2  
27 rue Victor Grignard  
CS 31107  
86 061 POITIERS  
Tel : 05 49 62 66 30



## Lot Eoliennes :

**NORDEX**  
194 Avenue du  
Président Wilson  
93 210 LA PLAINE SAINT-DENIS  
Tel : 01 55 93 43 43



## Contrôleur technique Electrique :

**BUREAU VERITAS CONSTRUCTION**  
2, rue Michel Labrousse - Bât. 15  
BP 64797  
31047 Toulouse Cedex 1  
Tel : 09 69 39 10 09



## Lot Voiries / Terrassement :

**COLAS AGENCE DE POITIERS**  
Zi de Larnay  
22 avenue Marcel Dassault  
86 580 Biard  
Tél : 05 49 58 65 75



## Lot Génie Civil :

**FONDASOLUTIONS**  
162, avenue de la Cigalière  
84250 LE THOR  
Tel : 04 32 74 15 60



## Lot Réseaux :

**INEO CENTRE**  
24, rue du Point du Jour  
41 350 ST GERVAIS LA FORET  
Tel : 02 54 50 50 89



## Lot Poste de livraison :

**SEL GROUPE**  
ZA des Petits Paçaux  
11 rue Louis Blériot  
59 660 MERVILLE  
Tel : 03 28 50 00 15



## Lot Câblage :

**CALLU**  
Le Bourg  
41 270 LE POISLAY

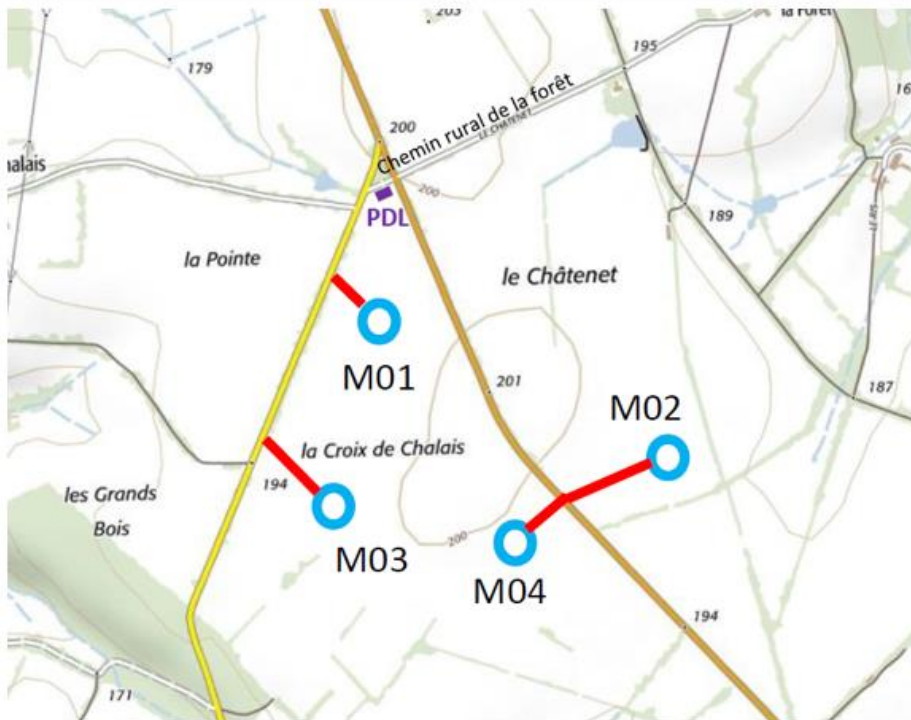

Numeros d'urgence	
SAMU	15
POLICE	17
POMPIERS	18
URGENCE	112
CENTRE ANTI-PANON TEL :	

# Intervenants Croix de Mérotte



## Construction du parc éolien de la Croix de Mérotte Commune de MILLAC



**terra energies**  
FONDS D'INVESTISSEMENT RÉGIONAL  
DE LA NOUVELLE-AQUITAINE









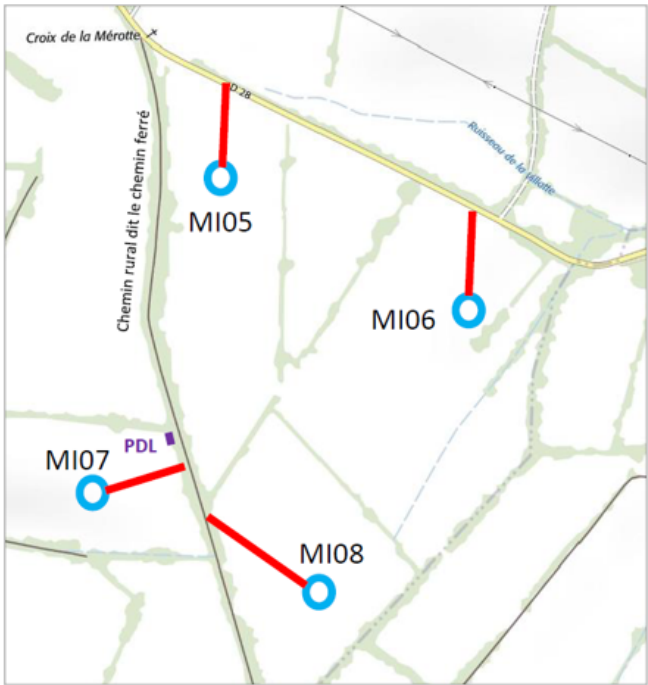

**BANQUE des  
TERRITOIRES**



Canal des Charentes





<p style="text-align: center;"><b>Maître d'Ouvrage</b> <b>Brimborion Energie</b> 78 avenue Jacques Cœur 86000 POITIERS</p>	<p style="text-align: center;"><b>Assistent au Maître d'Ouvrage</b>  <b>énergie environnement</b> 12 rue Martin Luther king 14280 SAINT CONTEST</p>
<p><b>Coordonnateur SPS :</b> <b>SOCOTEC CONSTRUCTION</b> Domaine du Millénum 3 impasse Henry le Chatelier 33 692 MERIGNAC CEDEX Tel : 05 57 29 06 10</p> <div style="text-align: center;">  </div>	<p><b>Contrôleur technique :</b> <b>APAVE</b> 27 Rue Victor Grignard 86000 POITIERS Tel : 05 49 62 66 30</p> <div style="text-align: center;">  </div>
<p><b>Lot Eoliennes :</b> <b>NORDEX</b> 194 Avenue du Président Wilson 93 210 LA PLAINE SAINT-DENIS Tel : 01 55 93 43 43</p> <div style="text-align: center;">  </div>	<p><b>Lot Poste de livraison :</b> <b>SEL GROUPE</b> ZA des Petits Pacaux 11 rue Louis Blériot 59 660 MERVILLE Tel : 03 28 50 00 15</p> <div style="text-align: center;">  </div>
<p><b>Lot Voiries / Terrassement :</b> <b>COLAS AGENCE DE POITIERS</b> Zi de Larnay 22 avenue Marcel Dassault 86 580 Biard Tel : 05 49 58 65 75</p> <div style="text-align: center;">  </div>	<p><b>Lot Génie Civil :</b> <b>FONDASOLUTIONS</b> 162, avenue de la Cigalière 84250 LE THOR Tel : 04 32 74 15 60</p> <div style="text-align: center;">  </div>
<p><b>Lot Réseaux :</b> <b>INEO CENTRE</b> 24, rue du Point du Jour 41 350 ST GERVAIS LA FORET Tel : 02 54 50 50 89</p> <div style="text-align: center;">  </div>	<p><b>Lot Câblage :</b> <b>CALLU</b> Le Bourg 41 270 LE POISLAY</p>



**DANGER  
ELECTRIQUE**

**CHANTIER INTERDIT  
AU PUBLIC**







POINT DE  
RASSEMBLEMENT

n° ICPE 2019-DCPPAT/BE-077  
Puissance de 12 MW  
4 éoliennes

20

**SUR L'ENSEMBLE  
DU CHANTIER**

PORTEZ VOS EQUIPEMENTS DE PROTECTION



## Caractéristiques des projets

### Parc éolien de la Croix de Chalais

- 4 éoliennes N117 de 120 m hauteur de moyeu
- 180 m en bout de pale
- Puissance unitaire de 3 MW – Capacité totale installée 12 MW
- Raccordement sur le poste source de l'Isle Jourdain (4 km)

### Parc éolien de la Croix de la Mérotte

- 4 éoliennes N117 de 120 m hauteur de moyeu
- 180 m en bout de pale
- Puissance unitaire de 3 MW – Capacité totale installée 12 MW
- Raccordement sur le poste source de Confolens (25 km)





## Réalisation des pistes et des plateformes





# Excavations



## Réalisation des fondations

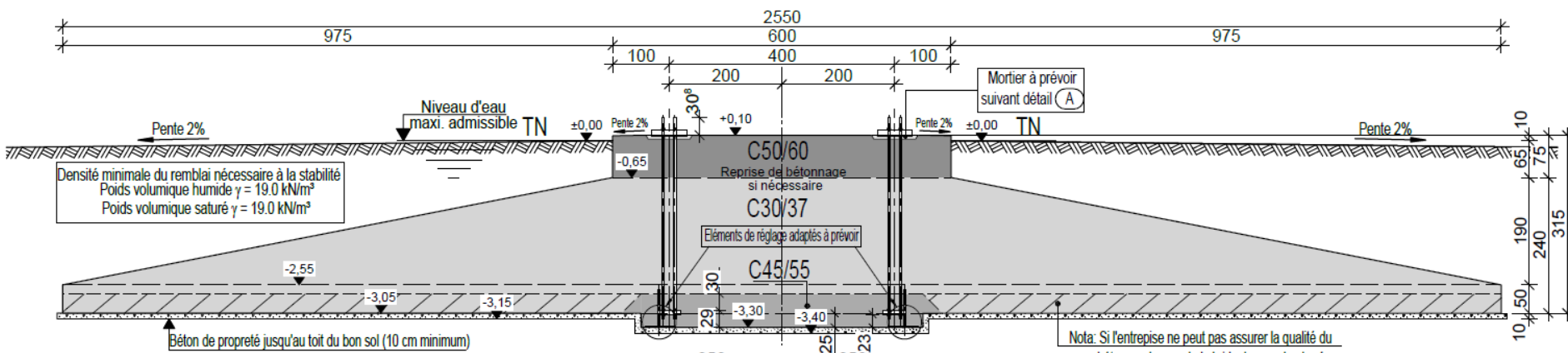

- Massifs Poids d'un diamètre de 25,5 m et d'une hauteur de 3,15 m.
- Cubage en béton de 700 m<sup>3</sup> et 79 tonnes d'acier pour chaque fondation.
- Chaque massif est coulé sur une seule journée. Total de 8 journées de coulage.



## Béton de propreté et installation des fourreaux



## Mise en place d'une cage d'ancrage





## Ferrailage et cage d'ancrage





## Coulage du béton



## Remblais





## Travaux de câblage





## Postes de livraison



## Contacts



### Contacts Construction

Manon DREUILHE

*Responsable construction*

06.86.64.55.03

[manon.dreuilhe@jpee.fr](mailto:manon.dreuilhe@jpee.fr)

Benjamin DEHERRE

*Chef de projet Construction*

07.78.38.50.21

[benjamin.deherre@jpee.fr](mailto:benjamin.deherre@jpee.fr)



### Contacts Maîtrise d'Ouvrage



### Croix de Chalais

Cédric DESSAILLY

*Directeur*

06.19.50.27.28

[cedric.dessailly@jpee.fr](mailto:cedric.dessailly@jpee.fr)

Xavier NASS

*Directeur Général*



### Croix de Mérotte

Amandine SOLEILHAC

*Responsable construction*

07.61.99.72.14

[amandine.soleilhac@sergies.fr](mailto:amandine.soleilhac@sergies.fr)

Hervé LECOMTE

*Directeur Général*